

IEA Wind Task 46

Erosion of wind turbine blades

D4.2 Erosion failure modes in leading edge systems

Technical report

Nicolai Frost-Jensen Johansen

DTU Wind and Energy Systems



iea wind

Technical Report

Erosion failure modes in leading edge systems

Prepared for the

International Energy Agency Wind Implementing Agreement

Prepared by

Nicolai Frost-Jensen Johansen, DTU Wind and Energy Systems

June 2023

IEA Wind TCP functions within a framework created by the International Energy Agency (IEA). Views, findings, and publications of IEA Wind do not necessarily represent the views or policies of the IEA Secretariat or of all its individual member countries. IEA Wind is part of IEA's Technology Collaboration Programme (TCP).

Purpose

This report summarises the current state-of-the-art for erosion failure modes in leading edge systems of wind turbine blades. This study was completed to provide a baseline for the activities in Work Package 4 of *IEA Wind Task 46 Erosion of wind turbine blades*. This report is released for public dissemination.

IEA Wind Task 46 Participants during period 2021-2025

Country	Contracting Party	Active Organizations
Belgium	The Federal Public Service of Economy, SMEs, Self-Employed and Energy	Engie
Canada	Natural Resources Canada	WEICan
Denmark	Danish Energy Agency	DTU, Hempel, Ørsted A/S
Finland	Business Finland	VTT
Germany	Federal Ministry for Economic Affairs and Energy	Fraunhofer IWES, Covestro, Emil Frei (Freilacke), Nordex Energy SE, DNV, Mankiewicz, RWE
Ireland	Sustainable Energy Authority of Ireland	Institute of Technology Carlow, University of Galway, University of Limerick
Japan	New Energy and Industrial Technology Development Organization	AIST, Osaka University, Tokyo Gas Co. Asahi Rubber Inc.
Netherlands	RVO	TU Delft, Eneco, Suzlon, TNO
Norway	Norwegian Water Resources and Energy Directorate	Equinor, University of Bergen
Spain	CIEMAT	Aerox, CENER, Nordex Energy Spain, Siemens Gamesa Renewable Energy, Universidad Cardenal Herrera - CEU
United Kingdom	ORE Catapult	ORE Catapult, University of Bristol, Lancaster University, Imperial College, Vestas UK
United States	U. S. Department of Energy	Cornell University, Sandia National Laboratories, 3M

Table of Contents

Purpose	3
1 Introduction	6
2 Damage observations and definitions	7
2.1 Examples.....	8
3 Description of damage types	9
3.1 Pre incubation - Homogeneous roughening	10
3.2 End of Incubation - Initial material removal.....	12
3.3 Incubation - Point erosion	14
3.4 Failure before incubation - failure at n to n-1 layer interface.....	16
3.5 Breakthrough to substrate	18
3.5.1 Breakthrough to substrate – cohesive failure.....	18
3.5.2 Breakthrough to substrate – adhesive failure	20
3.5.3 Breakthrough of substrate	22
4 Summary of the questionnaire:	24
4.1 Visual Damage Detection	27
4.1.1 Computer Vision.....	27
4.1.2 Manual Detection.....	27
4.1.3 In-situ vs Ex-situ Detection.....	27
4.2 Surface Scan.....	27
4.2.1 Gloss Measurement	27
4.2.2 Roughness	27
4.2.3 Full Surface Mapping.....	27
4.2.4 Volume Loss Measurement.....	27
References	28

Executive Summary

This report is output of Work Package 4 'Laboratory testing of erosion' in IEA Wind Task 46 'Erosion of wind turbine blades'. This report on erosion failure modes in leading edge systems address a system for visual identification of rain erosion under accelerated testing. This is inspired by the D3.2 report. The work is compiled from a display of several damage of specimen and the results from a comprehensive questionnaire to participants in the work package.

1 Introduction

The leading edge of wind turbine blades is subject to harsh environmental conditions, including rain erosion, which can cause significant damage to the materials and coatings used for protection. As a result, accelerated rain erosion testing has become a critical component in assessing the long-term durability and performance of these materials.

In recent years, there has been a resurgence of rain erosion testing, resulting in a greater degree of standardization across the industry. As of 2023, around 15 machines worldwide conform to the DNV-GL RP-0171 guidelines for "Testing of rotor blade erosion protection systems." However, to ensure accurate and consistent assessments of material performance, it is essential to develop a common framework for evaluating and discussing rain erosion test results.

This document aims to provide a common framework for evaluating and disseminating accelerated erosion test results. It serves as a supplement to DNV-GL recommended practices RP-0171 and RP-0573, providing guidance on identifying damages and determining the appropriate damage state for lifetime calculations. By establishing a standard framework for analyzing and discussing rain erosion testing results, this document will improve the accuracy and consistency of material performance assessments.

The document begins with an overview of the leading edge configurations and the types of damage that can occur during rain erosion testing. It then provides a description of the various damage states, from early stage damages to late stage damages, to enable consistent reporting of damage levels across different materials and test conditions.

Ultimately, the goal of this document is to provide a practical guide for assessing rain erosion testing results that can be used by engineers, researchers, and industry professionals to improve the durability and performance of materials in harsh environments. Figure 1 shows sketch of damage at specimen.

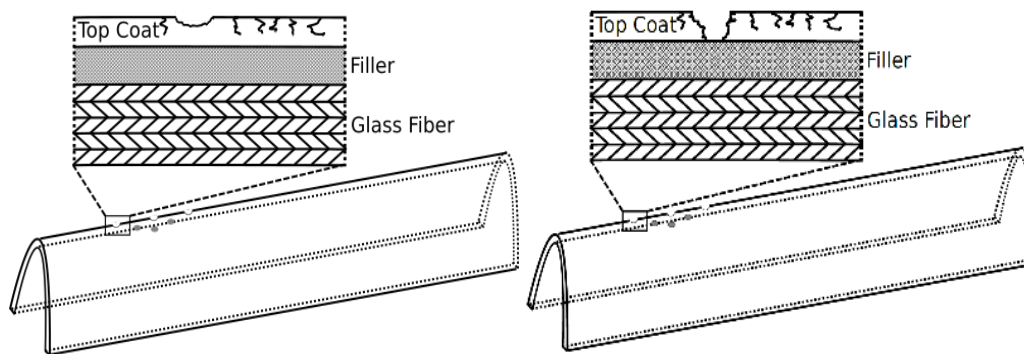

Figure 1: Sketches of rain erosion test specimen with damage.

Based on the experience of participants in WP4, the recommended approach for identifying damage during the incubation stage in DNV-GL RP-0171 [1] and 0573 [2] is to visually identify isolated areas of

material loss between 0.1 and 4mm². For coatings thinner than 1mm, point erosion, the full removal of an isolated area of the Nth layer, is recommended due to its ease of identification, especially if the underlying layer has a contrasting color. For thick coatings like shell solutions with thickness more than 1mm, damages of the same size between 0.1 and 4mm² should be marked and classified as initial erosion. However, initial erosion may be more challenging to visually detect due to the lack of contrast.

During each observation of the blade, only new damages should be recorded, and these damages must not be directly connected to neighboring areas of damage with a minimum of 2 damage diameters between recorded damages. This approach ensures that each identified damage is recorded accurately and independently without duplicating or combining damages.

2 Damage observations and definitions

A rain erosion test specimen is characterized by a specific leading edge configuration. In order to characterize the damage, first the specific LE configuration of the structure is identified. A leading edge configuration is composed by a number of layers, N. Layer 0 is by definition the fiber reinforced polymer structure of the blade/substrate. See Table 1.

Table 1: Definition of layers.

Layer N: Outer layer –LEP coat/tape/shell ect.
Layer N-1: Layer underneath the outer layer e.g. primer or topcoat under LEP
Layer x: Additional intermediate layers..
Layer 1: Typically filler / primer / putty ect.
Layer 0: Top layer of the substrate / GF of the blade
Layer –1: For erosion progressing into the structure, e.g. different layers of laminate, Bx, UD ect.

To elaborate further, the leading edge configuration typically includes several layers(N) of coatings and/or laminates applied to the surface of the blade substrate to protect against rain erosion. The number and type of layers may vary depending on the design and specifications of the wind turbine blade.

Layer 0, the substrate or the fiber reinforced polymer structure, is the base layer of the leading edge configuration. It provides the primary structural support for the blade and is typically composed of a composite material such as fiberglass or carbon fiber reinforced polymer.

Above the substrate layer, there may be additional layers (1..N) of coatings or materials that are designed to provide protection against rain erosion. These layers may include a filler layer, surface coating layer, and a leading edge protection layer (LEP).

The goal in numbering layers, is to remove the ambiguity that arises when discussing what is topcoat, LEP, shell, or tape. In this way the nature of the damage and failure mode can be clearly communicated without disclosing product specific information. E.g instead of stating failure between topcoat and LEP tape, the failure would be between Layer: N and Layer: N-1 and so forth.

In addition to the layers mentioned, the leading edge configuration may also include layers for lightning protection, adhesive layers for bonding the coatings and laminates, and edge sealing layers to prevent water ingress.

It is important to note that each layer in the leading edge configuration may have different properties and thicknesses, and therefore may provide different levels of protection against rain erosion. The failure or damage of a particular layer can have different implications on the overall performance and durability of the blade.

The identification and characterization of damage on the leading edge configuration is crucial in determining the remaining useful life of the wind turbine blade, as well as in developing maintenance and repair strategies to ensure safe and efficient operation of the wind turbine.

2.1 Examples

In a 2-layer configuration, Layer 0 is the substrate layer, while Layer 1 is the top layer that provides protection against rain erosion. Figure 2 illustrates a typical 2 layer configuration for a wind turbine blade, where Layer 2 is the topcoat which is directly subjected to the rain loads.

During a rain erosion test, the damage and failure modes between the layers can be identified by referring to the layers by their respective numbers. For instance, if the damage occurs between Layer 1 and Layer 0, it would be classified as damage between the filler and the substrate.

In a typical case we could judge incubation damage to be fully confined to the N'th layer however, consider ratio to thickness of the coating need to be taken into account.

Layer 2: Top coat
Layer 1: Filler/putty
Layer 0: Blade structure – typically glass fibre-polyester or glass-epoxy

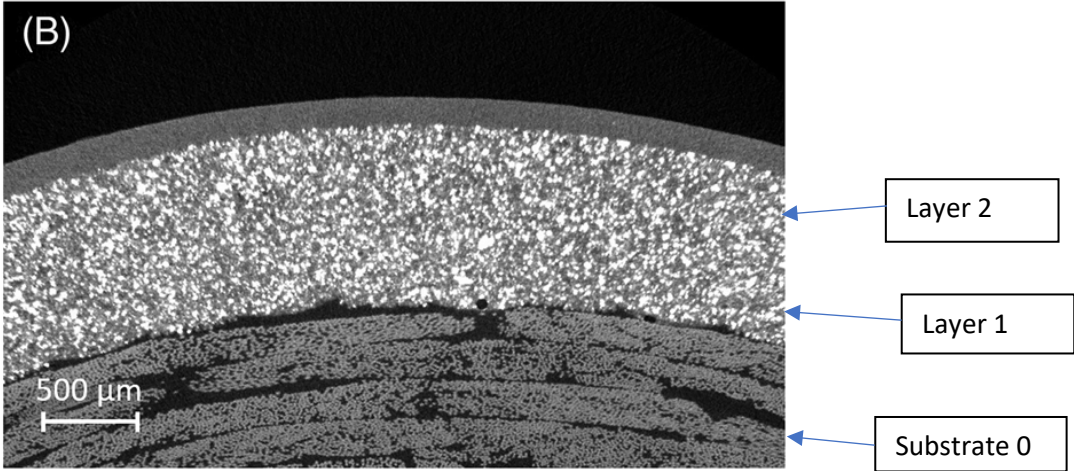

Figure 2: Cross section of rain erosion test specimen.

3 Description of damage types

The following chapter contain in brief descriptions of typical damage states observed on materials subjected to rain erosion testing (RET). The goal here is to provide a common framework for discussing the types of damages observed ensuring that failures modes can be clearly communicated.

The “end of incubation is defined as the initiation of material loss. Cracks, debonding and aother damage may occur during the incubation period.

The damages types are listed from early stage damages to late stage damages, see Figure 3. The damage images from different stages of erosion are shown in Figures 4 to 10 including supporting text.

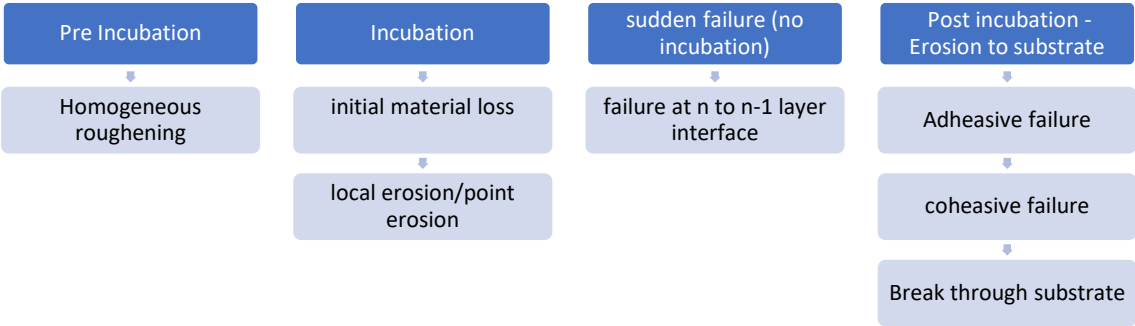

Figure 3: Overview of damage classes.

3.1 Pre incubation - Homogeneous roughening



Description						Defect Appearance					
The defect type is characterized by morphology change with little to none material removal. Typically seen on homogeneous materials. It is usually the first defect appearing during a RET. As can be seen on the illustration, the rough/matt appearance occur because of crack formation in the n layer (LEP). These cracks results in reflected light being diffused giving rise to the matt appearance						The appearance is very dependent on the material, on metallic surfaces it is seen as a loss of gloss. On Clear coatings it can be seen as cracks normal to the surface as illustrated					
Affecting layers						This type of defect is similar to initial material removal. Can also look like point erosion.					
Coating specific layer name	LEP	Coating	Filler	Surface laminate	Laminate						
Layer number	n	n-1	n-2	0	-1	Approximate IEA erosion severity Level:					
Affecting layers	x										
Example images											
Illustration	1					2					
											

Figure 4: Damage images for pre-incubation.

Damage Class 1:

- "Is the description clear and unambiguous":

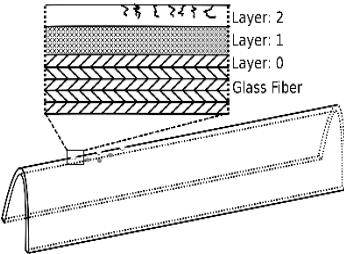
- Mean: 3.79
- Standard Deviation: 1.47
- Margin of Error (95%): 0.65
- Confidence Interval (95%): (3.14, 4.44)
- "Approximate IEA erosion severity level":
 - Mean: 1.74
 - Standard Deviation: 1.34
 - Margin of Error (95%): 0.59
 - Confidence Interval (95%): (1.15, 2.33)

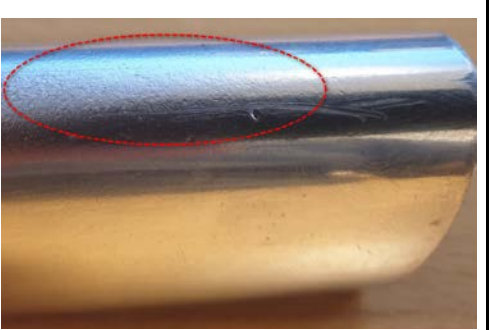
3.2 End of Incubation - Initial material removal



Description						Defect Appearance					
The defect is characterized by local material loss and is usually the starting point of erosion development. The damage is within a confined area without connecting to preexisting erosion, limited to the top coating within a single layer.						Defect size is equal to coating thickness squared or smaller. The damage is entirely confined to the outer n layer with no penetration					
						Interchangeable defects					
Affecting layers						<ul style="list-style-type: none"> Homogeneous roughening – distinct spots with clear difference from the neighboring area Local erosion – Limited to single layer 					
Example of coating specific layer name	LEP	Coating	Filler	Surface laminate	Laminate						
Layer number	n	n-1	n-2	0	-1	Approximate IEA erosion severity Level:					
Affecting layers	x					0: 29%	1: 14%	2: 14%	3	4:28%	5:14%
Example images											
Illustration		1				2					
											

Figure 5: Damage images for end of incubation.

Damage Class 2:

- "Is the description clear and unambiguous":
 - Mean: 3.79
 - Standard Deviation: 1.60
 - Margin of Error (95%): 0.70

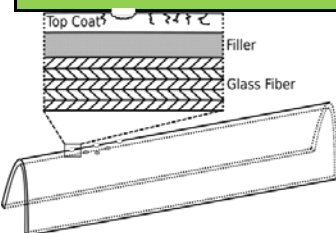
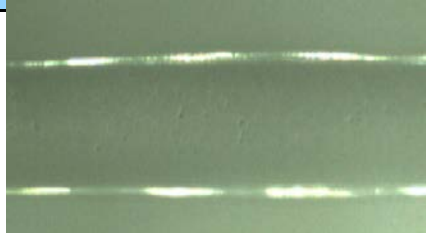
- Confidence Interval (95%): (3.09, 4.49)
- "Approximate IEA erosion severity level":
 - Mean: 1.58
 - Standard Deviation: 1.48
 - Margin of Error (95%): 0.65
 - Confidence Interval (95%): (0.93, 2.23)

3.3 Incubation - Point erosion



Description						Defect Appearance					
<p>The defect is characterized by local material loss exposing an underlying layer. This is usually the starting point of erosion development. The damage is within a confined area without connecting to preexisting erosion. Within this area, the defect can propagate to the underlying area.</p>						<p>Defect size is equal to coating thickness squared or larger. The damage has removed part of the n layer exposing the n-1 layer. Typically, underlying layers have different colors to the top coating. This makes this type of damage, relatively easy to identify. And</p>					
Affecting layers						<ul style="list-style-type: none"> • Initial material removal • Homogeneous roughening 					
Example of coating specific layer name	LEP	Coating	Filler	Surface laminate	Laminate						
Layer number	n	n-1	n-2	0	-1						
Affecting layers	x	x	(x)			0:	1:29%	2:14%	3:14%	4:29%	5: 14%
Example images											
Illustration		1				2					
											

Figure 6: Damage images for incubation, point erosion.

- "Is the description clear and unambiguous":
 - Mean: 3.74
 - Standard Deviation: 1.39
 - Margin of Error (95%): 0.61
 - Confidence Interval (95%): (3.13, 4.35)
- "Approximate IEA erosion severity level":
 - Mean: 1.79
 - Standard Deviation: 1.37
 - Margin of Error (95%): 0.60
 - Confidence Interval (95%): (1.19, 2.39)

3.4 Failure before incubation - failure at n to n-1 layer interface

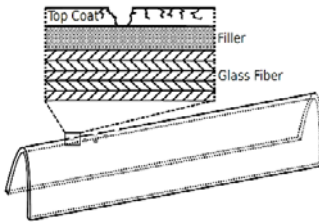

Description						Defect Appearance					
This failure mode covers adhesive failure between layers in the coating system this can be between LEP and topcoat, or LEP to porefiller. Also seen on tape/shell solution as failure of the adhesive to n layer interface. This can also result from a local defect, on cohesively strong coatings. When the coatings tensile strength exceeds the adhesive strength at the interface peeling can occur						Typically presents as peeling of the coating					
						Underlying layer relatively undamaged					
						Interchangeable defects					
						Point erosion can be due to this type of failure					
Affecting layers											
Example of coating specific layer name	LEP	Coating	Filler	Surface laminate	Laminate						
Layer number	n	n-1	n-2	0	-1	Approximate IEA erosion severity Level:					
Affecting layers	x	x	(x)			0:	1	2:42%	3:14	4:29%	5:14%
Example images											
Illustration			1			2					
 <p>Layer=n LEP Layer=n-1 e.g filler Layer=0 Biax</p>											

Figure 7: Failure before incubation - failure at n to n-1 layer interface.

- "Is the description clear and unambiguous":
 - Mean: 4.00
 - Standard Deviation: 1.15
 - Margin of Error (95%): 0.50
 - Confidence Interval (95%): (3.50, 4.50)

- "Approximate IEA erosion severity level":
 - Mean: 3.10
 - Standard Deviation: 1.10
 - Margin of Error (95%): 0.48
 - Confidence Interval (95%): (2.62, 3.58)

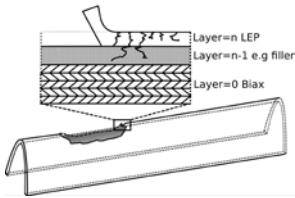
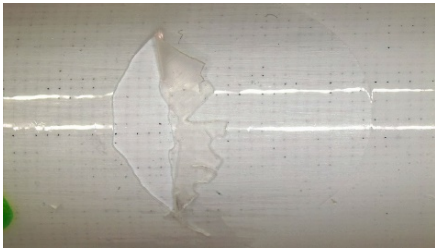
3.5 Breakthrough to substrate

The following covers 2 types of breakthrough to substrate, adhesive and cohesive. Breakthrough to substrate is a typical evaluation criterion when evaluating ultimate system lifetime. The exposed laminate surface indicates the quality of the bond between substrate and layer no. 1. A strong bond leads to cohesive failure whereas a weak bonding leads to adhesive failure, where the original texture of the laminate surface is exposed.

3.5.1 Breakthrough to substrate – cohesive failure

Description						Defect Appearance					
<p>The defect is defined by exposed substrate as a result of complete coating and filler material failure.</p> <p>The main characteristic of the defect type is that exposed laminate areas can be discreet. This failure indicates a good adhesion between the substrate and the coating layer(s).</p>						<ul style="list-style-type: none"> Discreet areas of failure On laminate substrates the damage follows the top layer fibre direction. Commonly 45 degree stripes are observed on fiberglass samples, due to the biax top layers 					
						Interchangeable defects					
Affecting layers						<ul style="list-style-type: none"> Adhesive failure – damage to the substrate is visible in the case of cohesive failure 					
Example of coating specific layer name	LEP	Coating	Filler	Surface laminate	Laminate						
Layer number	n	n-1	n-2	0	-1	Approximate IEA erosion severity Level:					
Affecting layers				x	x	0:	1	2	3:29%	4:42%	5:29%
Example images											
Illustration			1						2		



Figure 8: Breakthrough to substrate – cohesive failure.

- "Is the description clear and unambiguous":
 - Mean: 4.61
 - Standard Deviation: 0.71
 - Margin of Error (95%): 0.31
 - Confidence Interval (95%): (4.30, 4.92)
- "Approximate IEA erosion severity level":
 - Mean: 4.00
 - Standard Deviation: 0.77
 - Margin of Error (95%): 0.34
 - Confidence Interval (95%): (3.66, 4.34)

3.5.2 Breakthrough to substrate – adhesive failure

Description						Defect Appearance					
<p>The defect is defined by exposed substrate as a result of complete coating and filler material failure.</p> <p>The main characteristic of the defect type is that exposed substrate is within one large, connected area. The newly exposed substrate surface is mostly undamaged. The failure occurs in the interface between coating and substrate.</p>						<ul style="list-style-type: none"> Newly exposed substrate is undamaged Damaged area tends to grow radially during testing One large connected area 					
Affecting layers						<ul style="list-style-type: none"> Adhesive failure – damage to the substrate is visible in the case of cohesive failure 					
Coating specific layer name	LEP	Coating	Filler	Surface laminate	Laminate						
Layer number	n	n-1	n-2	0	-1	Approximate IEA erosion severity Level:					
Affecting layers				x		0:	1	2	3	4:71%	5:29%
Example images											
Illustration	1					2					
											

Figure 9: Breakthrough to substrate – adhesive failure.

- "Is the description clear and unambiguous":

- Mean: 4.21
- Standard Deviation: 0.95
- Margin of Error (95%): 0.42
- Confidence Interval (95%): (3.79, 4.63)
- "Approximate IEA erosion severity level":
 - Mean: 4.11
 - Standard Deviation: 0.83
 - Margin of Error (95%): 0.36
 - Confidence Interval (95%): (3.75, 4.47)

3.5.3 Breakthrough of substrate

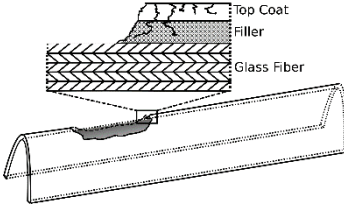
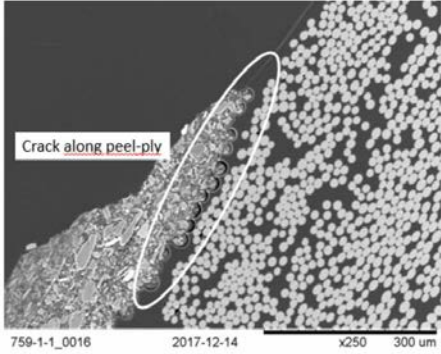
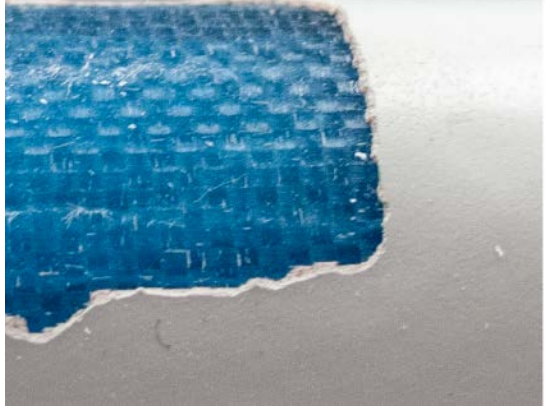
Description						Defect Appearance					
The damage is defined by damage through the full stack of substrate, exposing the air behind the LE. It is advisable that the rain erosion test is aborted at the stage of breakthrough of substrate.						<ul style="list-style-type: none"> Hole(s) through the substrate 					
						Interchangeable defects					
Affecting layers						<ul style="list-style-type: none"> Adhesive failure – damage to the substrate is visible in the case of cohesive failure 					
Coating specific layer name	LEP	Coating	Filler	Surface laminate	Laminate						
Layer number	n	n-1	n-2	0	-1	Approximate IEA erosion severity Level:					
Affecting layers				x	x	0:	1	2	3	4:29%	5:71%
Example images											
Illustration		1				2					
											

Figure 10: Breakthrough of substrate.

- "Is the description clear and unambiguous":
 - Mean: 4.68
 - Standard Deviation: 0.56
 - Margin of Error (95%): 0.25
 - Confidence Interval (95%): (4.43, 4.93)

- "Approximate IEA erosion severity level":
 - Mean: 4.89
 - Standard Deviation: 0.32
 - Margin of Error (95%): 0.14
 - Confidence Interval (95%): (4.75, 5.03)

4 Summary of the questionnaire:

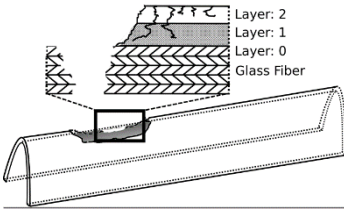
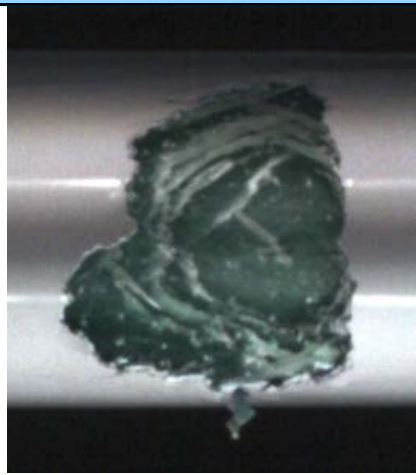
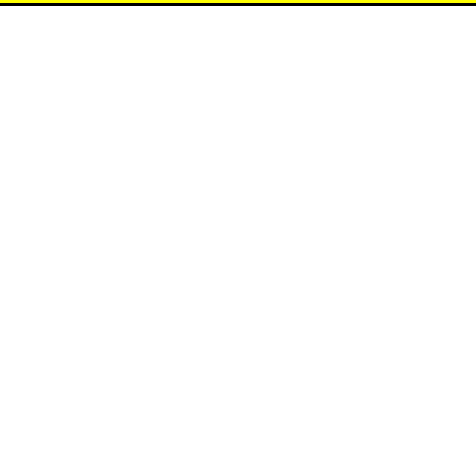
Overall, the majority of responses indicated that the 7 damage classes presented cover most of the failures observed during rain erosion testing. However, there were some suggestions for improvements to the system.

One respondent suggested considering whether all types of coating or filler materials exhibit the same classes of damage, or if different materials behave differently. This could help ensure that the system is applicable to a wide range of materials and not limited to just a few types.

Another suggestion was to define a clear point of failure for the LEP to allow for accurate comparisons between different coatings. Without a clear definition, it can be challenging to assess when a coating has failed, and comparisons between different coatings may not be reliable.

One respondent suggested adding homogeneous roughening/microcracking to the pre-incubation stage. This would provide a more comprehensive evaluation of the coating's resistance to erosion by considering its response to early stages of damage.

A related suggestion was to merge pre-incubation and incubation into one category, as it can be challenging to distinguish homogeneous roughening in some coatings. By combining these stages, the system could provide a more consistent and accurate evaluation of coatings' early resistance to erosion.

Another respondent suggested clarifying the differences between homogeneous roughening and the end of the incubation stage, possibly by differentiating based on the mass loss of the sample. This would help ensure that the system accurately assesses the different stages of damage a coating may undergo during testing.

Another suggestion was to provide deeper characterization for the "end of incubation" stage, particularly regarding the area and size of incubation. This could help identify the specific regions of a coating that are most susceptible to erosion and provide valuable information for future coating development.

Finally, one respondent suggested including a damage class to account for multiple point erosion locations converging into a larger spot but not yet penetrating the putty. This would help provide a more detailed evaluation of coatings' resistance to erosion and identify the specific regions of coatings that may need improvement.

Overall, these suggestions highlight some potential areas for improvement in the current rain erosion testing system. By considering these suggestions, future versions of the system could provide a more comprehensive evaluation of coatings' resistance to erosion and help identify areas for improvement in coating development.

The majority of responses indicate that the 7 damage classes cover most of the failures observed during rain erosion testing. However, some suggestions for improvements have been made:

1. Consider whether all types of coating or filler materials exhibit the same classes of damage, or if different materials behave differently.
2. Define a clear point of failure for the LEP to allow for accurate comparisons.
3. Merge pre-incubation and incubation into one category, as it can be challenging to distinguish homogeneous roughening in some coatings.
4. Clarify the differences between homogeneous roughening and the end of the incubation stage, possibly by differentiating based on the mass loss of the sample.
5. Provide deeper characterization for the "end of incubation" stage, particularly regarding the area and size of incubation.
6. Include a damage class to account for multiple point erosion locations converging into a larger spot but not yet penetrating the putty.

The suggestions for improvements to the system can be summarized as follows:

1. Consider adding homogeneous roughening/microcracking to the pre-incubation stage.
2. Merge pre-incubation and incubation into one category, as it can be challenging to distinguish homogeneous roughening in some coatings.
3. Clarify the differences between homogeneous roughening and the end of the incubation stage, possibly by differentiating based on the mass loss of the sample.
4. Provide deeper characterization for the "end of incubation" stage, particularly regarding the area and size of incubation.

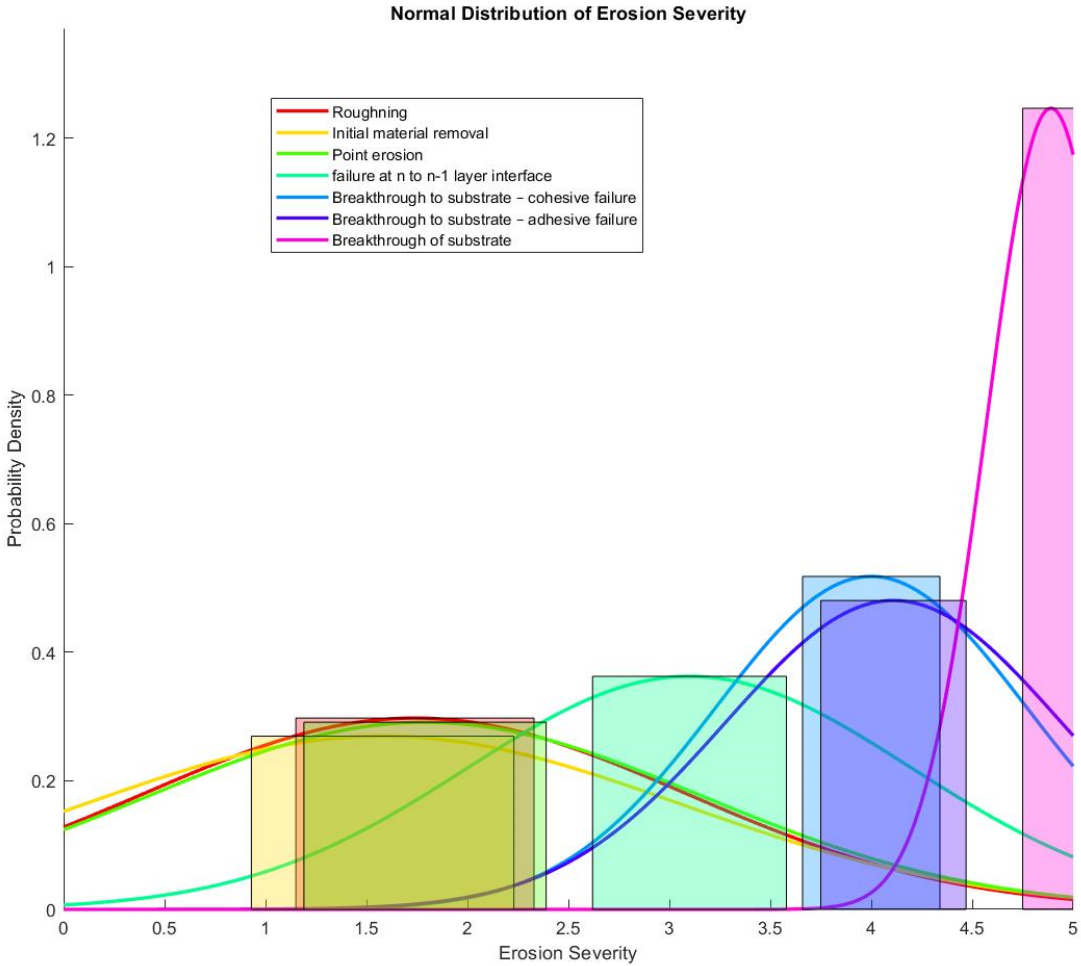

Figure 11: Summary of results from questionnaire.

Analysing responses to the questionnaire, roughning, initial material removal and point erosion get assigned a similar IEA erosion class. This might indicate that they should all be classified as incubation type damages. Figure 11 shows three incubation classes to overlay. The breakthrough to substrate whether cohesive or adhesive failure overlap. Failure at n to n-1 layer is distinct. Also breakthrough to substrate is distinct according to the results from the questionnaire.

4.1 Visual Damage Detection

4.1.1 Computer Vision

Computer vision techniques can be employed to automate the process of detecting and quantifying erosion damage on test specimens. By using image processing algorithms, it's possible to identify and classify different types of damages, such as roughening, material removal, and breakthroughs.

4.1.2 Manual Detection

Manual detection involves the visual inspection of test specimens by trained experts. Although this method may be more subjective and time-consuming than computer vision, it can still provide valuable insights into the damage state of a material.

4.1.3 In-situ vs Ex-situ Detection

In-situ detection refers to the assessment of erosion damage while the test is ongoing. This allows for real-time monitoring of damage progression. Ex-situ detection, on the other hand, involves analyzing the test specimen after the test has been completed. Both approaches have their benefits and limitations, and the choice depends on the specific requirements of the testing process.

4.2 Surface Scan

4.2.1 Gloss Measurement

Gloss measurement quantifies the amount of light reflected by the surface of a material. A decrease in gloss can indicate the presence of surface roughening or other early-stage erosion damages.

4.2.2 Roughness

Surface roughness measurements provide information about the texture and microstructure of a material's surface. An increase in roughness can signal the onset of erosion damage, such as incubation or point erosion.

4.2.3 Full Surface Mapping

Full surface mapping techniques create a detailed, three-dimensional representation of a material's surface. These methods can provide valuable information about the extent and severity of erosion damage.

4.2.4 Volume Loss Measurement

Volume loss measurement quantifies the amount of material that has been removed from the surface due to erosion. This metric can be used to assess the progression of erosion damage and determine the overall performance of a coating or material system.

References

- [1] DNV-RP-0171 Testing of rotor blade erosion protection systems, Recommended practice, Edition 2018-02 - Amended 2021-10
- [2] DNV-RP-0573 Evaluation of erosion and delamination for leading edge protection systems of rotor blades, Recommended practice, Edition 2020-12 - Amended 2021-10